

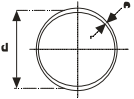

Ducto Eléctrico y Telefónico - ASTM

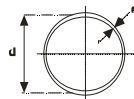

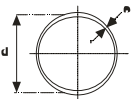

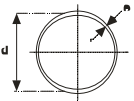
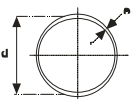
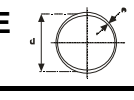

Descripción	Código	Diámetro	Emp. Mínimo	Precio Bs.F
Tipo Liviano CxE EB 20 Tramos de 6 mts 	928657	2	1	70,30
	928667	3	1	125,99
	928656	6	1	452,40
Tubería CxE Tipo Pesado DB 60 Tramos de 6 mts 	928670	3	1	176,50
	928672	6	1	601,28
Tubería CxE Norma Electricidad de Caracas Tramos de 6 mts 	928669	2	1	78,34
	928673	4	1	212,67
	928674	5	1	378,23
Tubería CxE DB 100 Norma GTE CANTV Tramos de 6 mts	928653	4	1	325,88
Tubería CxE Schedule 40 Tramos de 3mts 	928550	2	1	83,56
	928558	3	1	173,09
	928561	4	1	232,16
	928563	5	1	314,79
	928568	6	1	402,83
Tubería CXE Schedule 40 Tramos de 6mts 	928551	2	1	161,60
	928559	3	1	332,53
	928562	4	1	451,88
	928564	5	1	636,49
	928569	6	1	809,73
Tubería 200mm CxE Tramos de 6mts 	928654	200	1	1.153,35
Curva 45° Tipo DB CxE 	927727	3	1	106,46
	927728	4	1	198,17
	928197	6	1	436,88

[Consultar existencia](#)

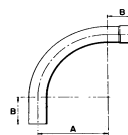
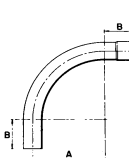
Ducto Eléctrico y Telefónico - ASTM

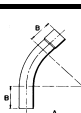

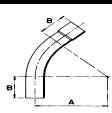
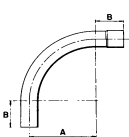
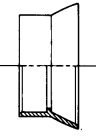
Descripción	Código	Diámetro	Emp. Mínimo	Precio Bs.F
Curva 90° Tipo DB CxE 	927730	3	1	124,05
	927731	4	1	257,16
	928205	6	1	464,71
Curva 90° CxE Tipo DB Electricidad de Caracas 	927729	2-r=46cm	1	47,70
	928200	4-r=46cm	1	192,71
	928201	4-r=76cm	1	204,33
	928203	5-r=46cm	1	246,75
	928204	5-r=90cm	1	306,92
Curva 45° Tipo EB CE CANTV 	928187	4-r=46cm	1	185,02
Curva 45° Tipo EB CxE Electricidad de Caracas 	928195	4-r=91cm	1	146,92
	928196	5-r=121cm	1	265,20
Curva 90° CxE Tipo EB - CANTV 	928200	4-r=46cm	1	192,71
Curva 45° CxE Schedule 40 	928256	2	1	33,97
	928258	3	1	53,27
	928267	4-r=42cm	1	105,03
	928270	6-r=76cm	1	253,28
Curva 90° CxE Schedule 40 	928274	2	1	30,90
	928277	3	1	84,67
	928278	4	1	109,34
	928279	5	1	207,96
	928280	6	1	253,28
Adaptador Terminal Campana Schedule 40 	928099	2	1	21,44
	928102	3	1	40,34
	928104	4	1	48,41
	928108	6	1	66,90

Consultar existencia

Ducto Eléctrico y Telefónico - ASTM

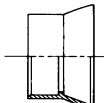
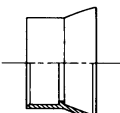
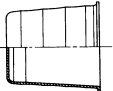

Descripción	Código	Diámetro	Emp. Mínimo	Precio Bs.F
Manchón de Unión Electricidad de Caracas 	928836	2	1	24,06
	928838	4	1	42,61
	928833	5	1	62,89
Adaptador Terminal Campana 	927673	3	1	25,37
	927678	4	1	38,61
	927680	6	5	87,02
Adaptador Electricidad de Caracas 	928098	2	1	19,22
	928103	4	1	46,39
	928105	5	1	56,60
	928107	6	1	63,10
Adaptador Terminal	928100	200	1	105,41
Tapón Ducto 	927765	3	50	4,80
	927766	4	50	8,44
	928368	5	1	40,29
	927767	6	10	60,95

Consultar existencia

Novaducto

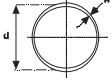

Descripción	Código	Díametro ext.	Díametro int.	Precio Bs.F
Tuberías Tramo de 3mts. 	929746	160	143	161,70

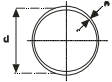
Tuberías Tramo de 6mts. 	929749	160	143	307,75
--	--------	-----	-----	--------

Descripción	Código	Díametro mm.	Precio Bs.F
-------------	--------	--------------	-------------

Adaptador Terminal Campana 	928097	160	84,57
---	--------	-----	-------

Unión 	928805	160	62,14
--	--------	-----	-------

Curva 90 ExC 	929748	160	211,23
---	--------	-----	--------

Tapón 	928366	160	64,01
---	--------	-----	-------

Acueducto

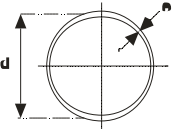
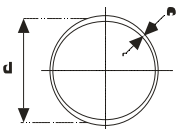
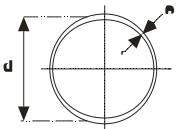
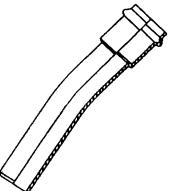
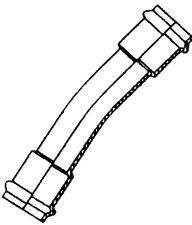

Descripción	Código	Diámetro	Precio Bs.F	
Tubería Junta Unisafe Clase AB Covenin 518 (142 psi) 10kg/cm2 ExJUS Tramos 6 mts, Unión con anillo elastómero y retén de polipropileno incluido		928585	75 x 3,6	195,74
		928632	110 x 5,3	416,96
		928650	160 x 7,7	929,13
		928664	200 x 9,6	1.457,75
		928684	250 x 11,9	2.319,86
		928513	315 x 15,0	3.574,64
		928519	400 x 19,1	5.716,57
928574	500 x 19,2	7.663,00		
Tubería Junta Unisafe - Clase AC Covenin 518 - (227 psi) 16kg/cm2 ExJUS - Tramos 6 mts, Unión con anillo elastómero y retén de polipropileno incluido		928586	75 x 5,6	318,57
		928633	110 x 8,2	672,41
		928648	160 x 11,9	1.414,09
Tubería Sistema Soldado Clase AB Covenin 518 (142 psi) 10kg/cm2 Tramos 6 mts.		928535	50 x 2,4	100,27
		928546	75 x 3,6	194,67
		928556	110 x 5,3	400,91
		928570	160 x 7,7	900,99
Curva 11,25° ExUnisafe		928227	75	129,78
		928215	110	396,47
		928217	160	1.166,81
		928219	200	1.817,68
		928221	250	2.130,24
		928223	315	3.357,32
		928225	400	5.464,40
Curva 11,25° Doble Junta Unisafe		928228	75	139,32
		928216	110	411,10
		928218	160	1.219,89
		928220	200	1.906,10
		928222	250	2.166,82
		928224	315	3.428,23
		928226	400	5.520,15

Consultar existencia

Acueducto

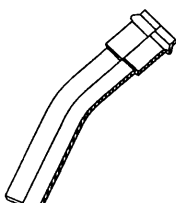
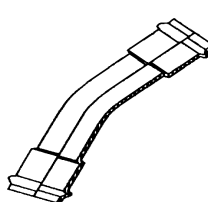
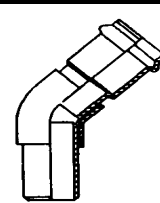
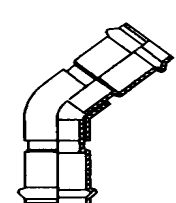
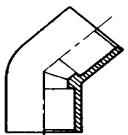

Descripción	Código	Diámetro	Precio Bs.F
Curva 22,50° ExJunta Unisafe 	928253	75	129,78
	928235	110	396,47
	928238	160	1.166,81
	928240	200	1.817,68
	928242	250	2.130,24
	928244	315	3.357,32
	928246	400	5.464,40
Curva 22,50° Doble Junta Unisafe 	928254	75	139,32
	928236	110	411,10
	928239	160	1.219,89
	928241	200	1.906,10
	928243	250	2.166,82
	928245	315	3.428,23
	928247	400	2.852,58
Codo 45° ExJunta Unisafe 	928137	75	147,48
	928082	110	364,21
	928084	160	1.007,30
	928086	200	1.331,07
	928087	250	3.198,24
	928088	315	3.834,91
Codo 45° Doble Junta Unisafe 	928138	75	168,39
	928083	110	392,34
	928085	160	1.071,44
	928119	200	1.438,34
	928120	250	3.770,13
	928121	315	5.949,97
Codo 45° Campana Para Soldar 	928142	75	93,78
	928169	110	278,71
	928171	160	686,75
	928128	200	1.053,48

Consultar existencia

Acueducto

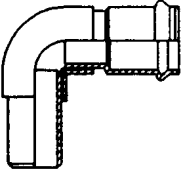
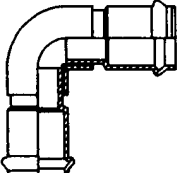
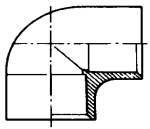
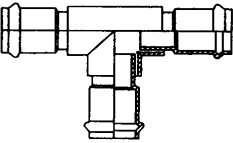
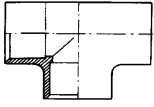

Descripción	Código	Diámetro	Precio Bs.F
Codo 90° ExJunta Unisafe 	928091	75	105,39
	928054	110	184,42
	928056	160	474,23
	928067	200	1.712,49
	928069	250	3.688,45
	928071	315	4.301,48
Codo 90° Doble Junta Unisafe 	928092	75	178,30
	928055	110	309,17
	928057	160	948,82
	928068	200	1.891,59
	928070	250	4.040,23
	928089	315	4.731,10
Codo 90° Campana Para Soldar 	928154	75	103,28
	928147	110	199,12
	928148	160	739,57
	928150	200	1.505,48
Tee Junta Unifase 	928398	75	121,20
	928395	110	263,46
	928403	160	658,65
	928404	200	1.053,83
	928405	250	4.215,39
	928397	315	9.484,61
Tee CC 	928482	75	111,16
	928485	110	254,45
	928486	160	874,96
	928474	200	948,75

Consultar existencia

"Los accesorios que aparecen en lista son para tubería clase AB, para clase AC se fabrican por encargo"

Acueducto



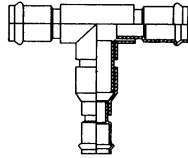
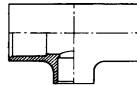
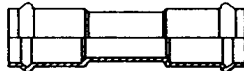
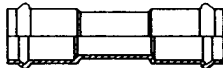
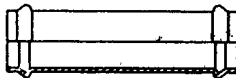



Descripción	Código	Diámetro	Precio Bs.F
Tee Reducida Junta Unisafe 	928499	110x75	515,72
	928502	160x110	1.254,35
	928508	200x160	2.597,75
	928471	250x200	3.871,07
	928472	315x250	7.035,11
Tee Reducida CC 	928503	110x75	363,47
	928504	160x110	1.261,24
Manchón Unión Junta Unisafe 	928734	75	177,86
	928698	110	236,02
	928713	160	471,75
	928714	200	628,94
	928715	250	828,07
	928716	315	1.236,88
928732	400	1.320,13	
Manchón Unión Junta Universal 	928733	50	23,71
Manchón Para Reparación Junta Universal Tipo Deslizante 	928831	75	57,21
	928828	110	105,33
	928847	160	837,02
	928848	200	1.281,29
	928849	250	2.381,43
	928850	315	4.075,05
	928851	400	8.154,29

"Los accesorios que aparecen en lista son para tubería clase AB, para clase AC se fabrican por encargo"

Consultar existencia

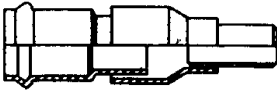
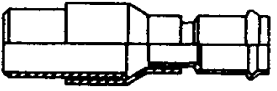
Acueducto

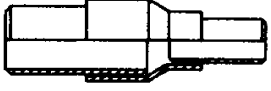

Descripción	Código	Diámetro	Precio Bs.F
Reducción Junta Unisafe 	928362	75x50	63,61
	928344	110x75	182,68
	928349	160x110	523,44
	928351	200x160	1.766,11
	928353	250x200	2.812,11
	928355	315x250	3.635,72
	928361	400x315	4.384,56
Reducción Junta Unisafe 	928343	110x75	176,11
	928348	160x110	494,77
	928350	200x160	1.696,01
	928352	250x200	2.691,83
	928354	315x250	3.460,12
	928356	400x315	3.936,12
	Reducción ExC 	928307	75x50
928290		110x75	149,12
928292		160x110	464,79
928294		200x160	1.643,82
Reducción ExE 	928308	75x50	77,68
	928291	110x75	163,38
	928293	160x110	487,21
	928295	200x160	1.678,09
	928297	250x200	2.669,16
	928300	315x250	3.401,21
	928304	400x315	3.823,41
Tapón Macho 	928379	75	80,81
	928371	110	143,54
	928372	160	336,84
Tapón Hembra C Para Soldar 	928387	75	65,31
	928384	110	231,81
	928386	160	322,38

Consultar existencia

Acueducto

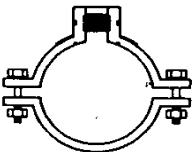
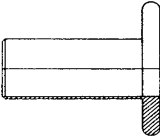
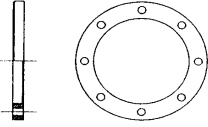
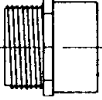

Descripción	Código	Diámetro	Precio Bs.F
Abrazadera Simple Rosca Hembra N.P.T 	928172	50x1/2"	22,59
	928174	50x3/4"	22,59
	928167	50x1"	22,59
	928177	75x1/2"	45,21
	928132	75x3/4"	45,21
	928176	75x1"	45,21
	928160	110x1/2"	85,93
	928161	110x3/4"	85,93
	928159	110x1"	85,93
	928165	160x1/2"	269,84
	928166	160x3/4"	269,84
	928162	160x1"	269,84
	Adaptador PVC-H.F E x Borde Batido Para Usar con Brida 	928012	75
928007		110	226,03
928008		160	470,06
928009		200	887,67
928010		250	1.134,23
Brida Loca 		928005	75
	928001	110	178,56
	928002	160	332,79
	928003	200	654,83
	928004	250	758,58
Adaptador Macho Rosca N.P.T CPS 	927612	1/2"	2,66
	927639	3/4"	3,71
	927555	1"	7,00

"Los accesorios que aparecen en lista son para tubería clase AB, para clase AC se fabrican por encargo"

Acueducto

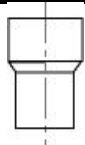
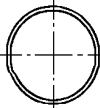

Descripción	Código	Diámetro	Precio Bs.F
Reducción CxCPS 	928323	75 x 50	88,65
	928313	110 x 75	88,65
	928315	160 X 110	347,88
Retén de Polipropileno Para Anillo Junta Unisafe 	6855	250	3,57
	6856	315	4,91
	6857	400	93,33

"Los accesorios que aparecen en lista son para tubería clase AB,
para clase AC se fabrican por encargo"

Alcantarillado Junta Unisafe

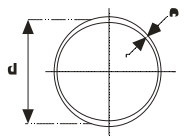
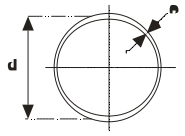
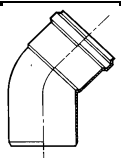
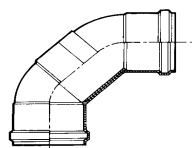
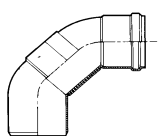
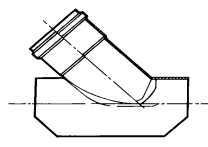

Descripción	Código	Diámetro	Precio Bs.F	
Tubería Junta Unisafe Norma DIN 19534 ExC Tramos 3mts Unión mediante Anillo Elastómero con Retén de Polipropileno (incluido)		928645	160x3,2	363,78
		928660	200x4,0	568,47
		928680	250x4,9	871,03
		928510	315x6,2	1.388,64
		928606	400x7,9	2.249,28
		928572	500 x 9,8	3.520,76
Tubería Junta Unisafe Norma DIN 19534 ExC Tramos 6mts Unión mediante Anillo Elastómero con Retén de Polipropileno (incluido)		928651	160x3,2	726,08
		928665	200x4,0	1.134,54
		928683	250x4,9	1.738,28
		928515	315x6,2	2.771,60
		928520	400x7,9	4.486,81
		928576	500 x 9,8	7.041,48
Codo 45° ExC Junta Unisafe		927560	160	156,57
Codo 90° CxC Junta Unisafe		927561	160	361,32
Codo 90° ExC Junta Unisafe		927562	160	225,83
Silla Yee Campana Junta Mecánica		928956	200 x 160	337,98
		927752	250 x 160	361,32
		928853	315 x 160	466,71
		928430	400 x 160	511,87
		928432	500 x 160	541,99

Consultar existencia

Alcantarillado Junta Unisafe



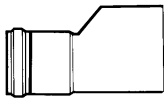
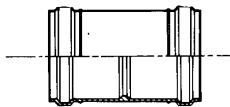



Descripción		Código	Diámetro	Precio Bs.F
Ampliación Excéntrica ExC Junta Unisafe 		928317	160 x 200	285,80
		928318	160 x 250	562,86
Unión CxC Junta Unisafe 		928807	160	563,41
		928809	200	640,76
		928811	250	1.244,91
		928813	315	1.419,00
		928814	400	2.035,46

[Consultar existencia](#)

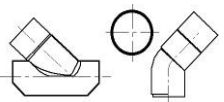
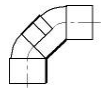

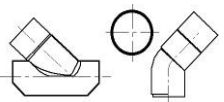
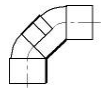
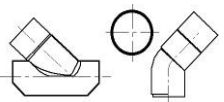
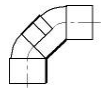
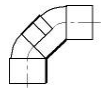

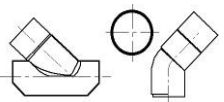
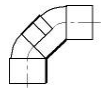
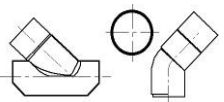
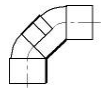
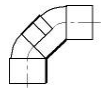
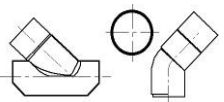
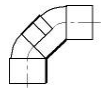
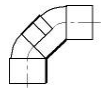
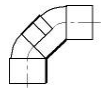
Alcantarillado Novafort



Descripción	Código	Diámetro Ext.	Diámetro Int.	Precio Bs.F																																								
Tubería de Doble Pared Estructurada. RS 4kN/m2 PS 28lb/plg2 E JA x C Tramos de 6 mts.	928646	160	143	292,68																																								
	928661	200	179	456,25																																								
	928681	250	227	671,21																																								
	928511	315	284	1.111,35																																								
	928885	400	362	1.941,95																																								
	927768	500	452	2.972,72																																								
Tubería de Doble Pared Estructurada. RS 4kN/m2 PS 28lb/plg2 E JA x C Tramos de 3 mts.	928643	160	143	153,80																																								
	928658	200	179	250,62																																								
	928678	250	227	367,00																																								
	928687	315	284	610,42																																								
	928884	400	362	1.059,26																																								
<table border="1"> <thead> <tr> <th>Descripción</th> <th>Código</th> <th>Diámetro mm.</th> <th>Precio Bs.F</th> </tr> </thead> <tbody> <tr> <td rowspan="4"> Unión  </td> <td>928806</td> <td>160</td> <td>152,08</td> </tr> <tr> <td>928808</td> <td>200</td> <td>220,47</td> </tr> <tr> <td>928810</td> <td>250</td> <td>353,71</td> </tr> <tr> <td>928812</td> <td>315</td> <td>473,24</td> </tr> <tr> <td colspan="5"> <table border="1"> <tbody> <tr> <td rowspan="4"> Kit para Empotramiento Incluye: 01 Silla Yee 02 Abrazaderas 01 Asiento Caucho 01 Codo 160 x 45°  </td> <td>928208</td> <td>200 x 160</td> <td>297,82</td> </tr> <tr> <td>928209</td> <td>250 x 160</td> <td>331,68</td> </tr> <tr> <td>928210</td> <td>315 x 160</td> <td>358,94</td> </tr> <tr> <td colspan="4"> <table border="1"> <tbody> <tr> <td> Codo 90°  </td> <td>928116</td> <td>160</td> <td>87,24</td> </tr> </tbody> </table> </td> </tr> </tbody> </table> </td> </tr> </tbody> </table>					Descripción	Código	Diámetro mm.	Precio Bs.F	Unión 	928806	160	152,08	928808	200	220,47	928810	250	353,71	928812	315	473,24	<table border="1"> <tbody> <tr> <td rowspan="4"> Kit para Empotramiento Incluye: 01 Silla Yee 02 Abrazaderas 01 Asiento Caucho 01 Codo 160 x 45°  </td> <td>928208</td> <td>200 x 160</td> <td>297,82</td> </tr> <tr> <td>928209</td> <td>250 x 160</td> <td>331,68</td> </tr> <tr> <td>928210</td> <td>315 x 160</td> <td>358,94</td> </tr> <tr> <td colspan="4"> <table border="1"> <tbody> <tr> <td> Codo 90°  </td> <td>928116</td> <td>160</td> <td>87,24</td> </tr> </tbody> </table> </td> </tr> </tbody> </table>					Kit para Empotramiento Incluye: 01 Silla Yee 02 Abrazaderas 01 Asiento Caucho 01 Codo 160 x 45° 	928208	200 x 160	297,82	928209	250 x 160	331,68	928210	315 x 160	358,94	<table border="1"> <tbody> <tr> <td> Codo 90°  </td> <td>928116</td> <td>160</td> <td>87,24</td> </tr> </tbody> </table>				Codo 90° 	928116	160	87,24
Descripción	Código	Diámetro mm.	Precio Bs.F																																									
Unión 	928806	160	152,08																																									
	928808	200	220,47																																									
	928810	250	353,71																																									
	928812	315	473,24																																									
<table border="1"> <tbody> <tr> <td rowspan="4"> Kit para Empotramiento Incluye: 01 Silla Yee 02 Abrazaderas 01 Asiento Caucho 01 Codo 160 x 45°  </td> <td>928208</td> <td>200 x 160</td> <td>297,82</td> </tr> <tr> <td>928209</td> <td>250 x 160</td> <td>331,68</td> </tr> <tr> <td>928210</td> <td>315 x 160</td> <td>358,94</td> </tr> <tr> <td colspan="4"> <table border="1"> <tbody> <tr> <td> Codo 90°  </td> <td>928116</td> <td>160</td> <td>87,24</td> </tr> </tbody> </table> </td> </tr> </tbody> </table>					Kit para Empotramiento Incluye: 01 Silla Yee 02 Abrazaderas 01 Asiento Caucho 01 Codo 160 x 45° 	928208	200 x 160	297,82	928209	250 x 160	331,68	928210	315 x 160	358,94	<table border="1"> <tbody> <tr> <td> Codo 90°  </td> <td>928116</td> <td>160</td> <td>87,24</td> </tr> </tbody> </table>				Codo 90° 	928116	160	87,24																						
Kit para Empotramiento Incluye: 01 Silla Yee 02 Abrazaderas 01 Asiento Caucho 01 Codo 160 x 45° 	928208	200 x 160	297,82																																									
	928209	250 x 160	331,68																																									
	928210	315 x 160	358,94																																									
	<table border="1"> <tbody> <tr> <td> Codo 90°  </td> <td>928116</td> <td>160</td> <td>87,24</td> </tr> </tbody> </table>				Codo 90° 	928116	160	87,24																																				
Codo 90° 	928116	160	87,24																																									

Alcantarillado Novafort

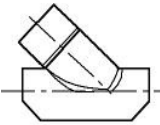
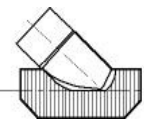

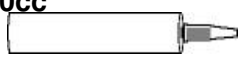
Alcantarillado Novafort				
Descripción	Código	Diámetro mm.	Precio Bs.F	
Codo 45° 	928110	160	72,72	
Adaptador 	927962	6" x 160	44,63	
Reducción Excéntrica	928941	250 x 160	242,47	
Silla YEE 	928416 928417 928429	200 x 160 250 x 160 315 x 160	157,15 177,10 192,20	
Silla YEE Corrugada 	928886 929157	200 x 160 250 x 160	141,53 156,47	
Asiento de Caucho para Silla	928112 928111 928113	200 x 160 250 x 160 315 x 160	28,36 39,18 53,26	
Descripción	Código	Diámetro	Cantidad	Precio Bs.F
Abrazadera de Acero Inoxidable para Silla YEE 	927969	200	1	57,92
	927970	250	1	59,18
	927971	315	1	73,95
Descripción	Código	Cantidad	Rend.	Precio Bs.F
Adhesivo Cartucho 310cc 	927979	1	2 Sillas 200 1,5 Sillas 250	126,82

Alcantarillado Novafort

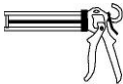

Descripción	Código	Cantidad	Rend.	Precio Bs.F
Acondicionador de Superficie Envase 250cc 	927951	1	1,2 Sillas 315 21 Sillas 200 18 Sillas 250 15 Sillas 315	216,27
Pistola Manual Para Cartucho 	928284	1		489,06

Rendimiento de la Soldadura de Alto Diámetro con la Silla Corrugada

Presentación de la Soldadura	Rendimiento/sillas	Cantidad de Soldadura/Silla	Diámetro (mm)
1/4	5.0	0.20	200
	4.0	0.25	250
1/8	2.5	0.40	200
	2.0	0.50	250